

PK100EC-THC

Installation and operating manual

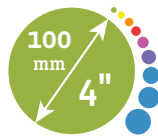

PK100EC-THC Installation and operating manual

Safety instructions

Please read the assembly and operating instructions before commissioning Prima Klima duct fans. Our fans are designed to promote indoor air in ventilation systems. To avoid the creation of condensation, fans should be isolated in unheated rooms. Fans can be commissioned only following successful installation in the ventilation system, or following the installation of protection against contact (EN ISO 13857). Suitable protection systems must be installed to protect the fan against the ingress of water from the sewage system. No moving parts may be present in the vicinity of the motor following installation. Fans are not suitable for operation in hazardous areas. Fans are allowed for indoor use only and must not come into contact with liquids. Outdoor operation is not possible. The power supply must be interrupted at all poles in the event of necessary maintenance. The motor impeller must be stationary before opening or maintenance. All Prima Klima fans have a temperature safety shut-off function that switches the engine off in the event of overheating. The engine will restart automatically once it has cooled.

Transport and storage

Prima Klima fans are securely factory packed so as to be protected against normal transport conditions. At temperature below 5° C, special transport conditions are required in order to avoid breakage of plastic, i.e. the box must be handled carefully. The fan may not be transported on a connection cable. Avoid exposure to shock and vibration. The fans must be stored in a dry place protected from the weather and dust at temperatures between -10 and 45°C.

Installation

The safety instructions detailed above must be observed. Assembly and electrical connection may only be performed by trained personnel. The relevant VDE and other applicable regulations must be observed. The electrical connection must be installed in accordance with the circuit described in the terminal box. The fan must be mounted in the correct flow direction (arrow on the sticker). The fan must be mounted that no vibrations are transmitted to the duct system. Fan noise can be avoided through the use of a suitable silencer.

The fan mounting bracket can be used to anchor the fan. Turn the fan to achieve the optimum assembly position. Ideally, the power supply should be at the bottom.

Caution! The metal mounting bracket is not burred so there is a risk of injury.

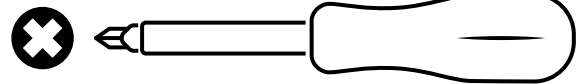
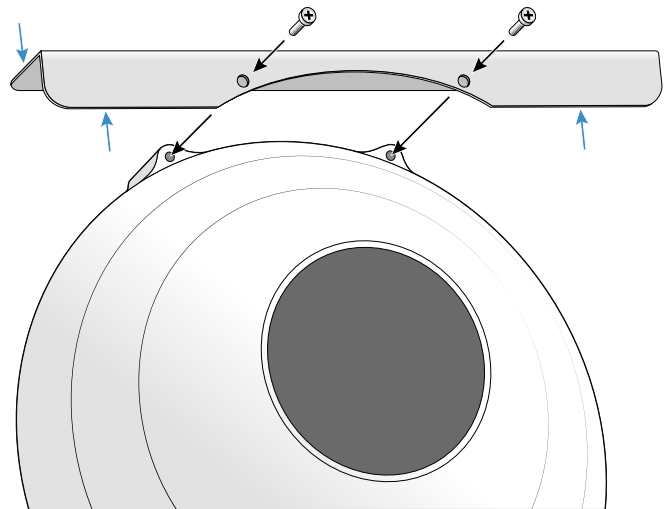

Tools required: Phillips screwdriver

Maintenance and repair

The fan must be disconnected from the power supply before maintenance or repair. The motor impeller must be stopped. Safety regulations must be complied with. To ensure a long lifecycle, the inside of the fan should be cleaned once per year. If the fan is not running, interrupt the power supply for a few minutes and try again. The motor requires approximately 20 seconds to go through its self-checking process before the motor restarts. If the fan still does not work, please contact your dealer.

How to adjust the fan correctly

Commissioning

Before switching on the fan, check if the electricity has been connected correctly. Has the protective conductor been connected? Has any leftover connection material been removed from the fan? Commissioning must be checked by trained personnel in accordance with regulations.

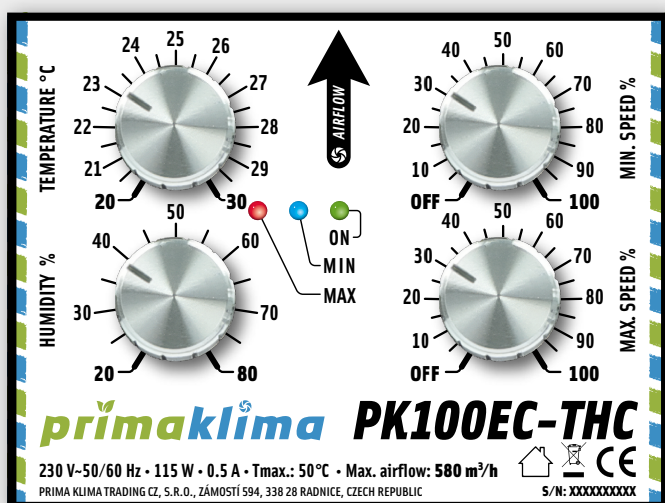

- **TEMPERATURE °C:** Set the desired temperature.
- **HUMIDITY %:** Set the desired humidity.
- **MIN. SPEED %:** Set the desired speed (reference: max. speed).
- **MAX. SPEED %:** Set the desired speed.
- **Red LED:** Fan is running on **MAX. SPEED**
- **Blue LED:** Fan is running on **MIN. SPEED**.
- **Green LED:** Power on.

The **TEMPERATURE** knob sets the target temperature, and the **HUMIDITY** knob sets the target humidity.

If either target value is exceeded, the fan runs at **MAX. SPEED**. Once both values drop below their targets, the fan reduces to **MIN. SPEED**.

The **MAX. SPEED** knob sets the fan's maximum output as a percentage of its full capacity. The **MIN. SPEED** knob sets the minimum running speed as a percentage of the configured Max. Speed.

Example:

MAX. SPEED is set to 50% → the fan runs at 50% of full capacity when the temperature or humidity target is exceeded.

MIN. SPEED is set to 50% → when both values are below their targets, the fan runs at 50% of 50% = 25% of full capacity.

ebm-pabst motors work extremely efficient in lower ranges of the rated power:

Air performance	Reduction in power consumption with ebm-papst EC-motors
100 %	10%
75%	49%
50%	77%
25%	94%

EU/EC declaration of conformity



As required by EC Directive

The Manufacturer – Prima Klima Trading CZ, s.r.o.;
Zámostí 594; CZ-33828 Radnice – hereby confirms
that the fans listed in this document comply with the
requirements of the following guidelines:

- Machinery Directive 2006/42/EC Annex II B
- Low Voltage Directive 2006/95/EC
- EMC Directive 2004/108/EC

The following guidelines are consistent with:

- EN 60204-1: 2006
- EN ISO 12100: 2010 Safety of Machinery
- General Principles for Design
- EN 13857 Safety of Machinery
- Safety distances in the danger zone of the upper and lower limb
- EN 60335-1 Electrical equipment for domestic use and similar purposes
- Part 1 General Requirements
- EN 60529 Protection class of housing IP CODE
- EN 61000-6-2 Electromagnetic compatibility of EMV

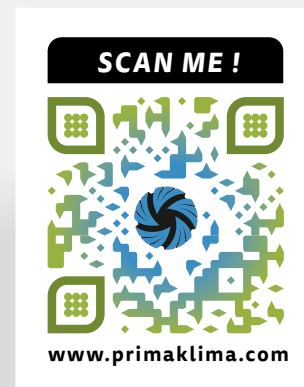

Ventilator is also available in the Set **PKVS-100EC-THC**

©PrimaKlima. Errors and omissions excepted. Illustrations similar. All rights reserved.

PRIMA KLIMA TRADING CZ, s.r.o.
Zámostí 594
338 28 Radnice
Czech Republic

Web
www.primaklima.com
[instagram.com/prima_klima](https://www.instagram.com/prima_klima)
[youtube.com/c/primaklima-horticulture](https://www.youtube.com/c/primaklima-horticulture)

E-Mail
sales@primaklima.com
Phone
+420 371 795 340

01.03.2026